

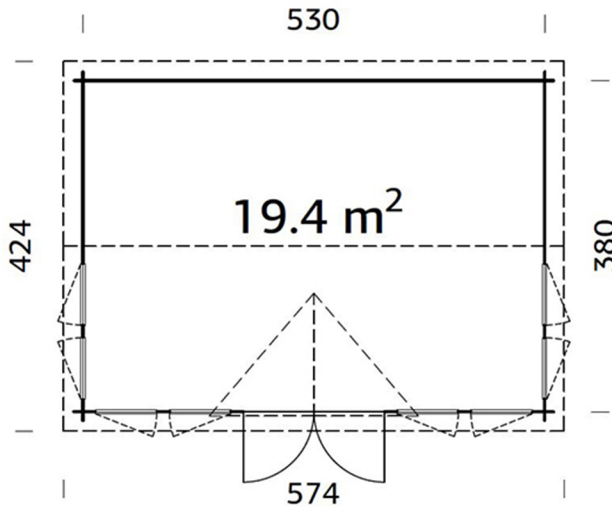

Carmen Floor Plan And Base Information

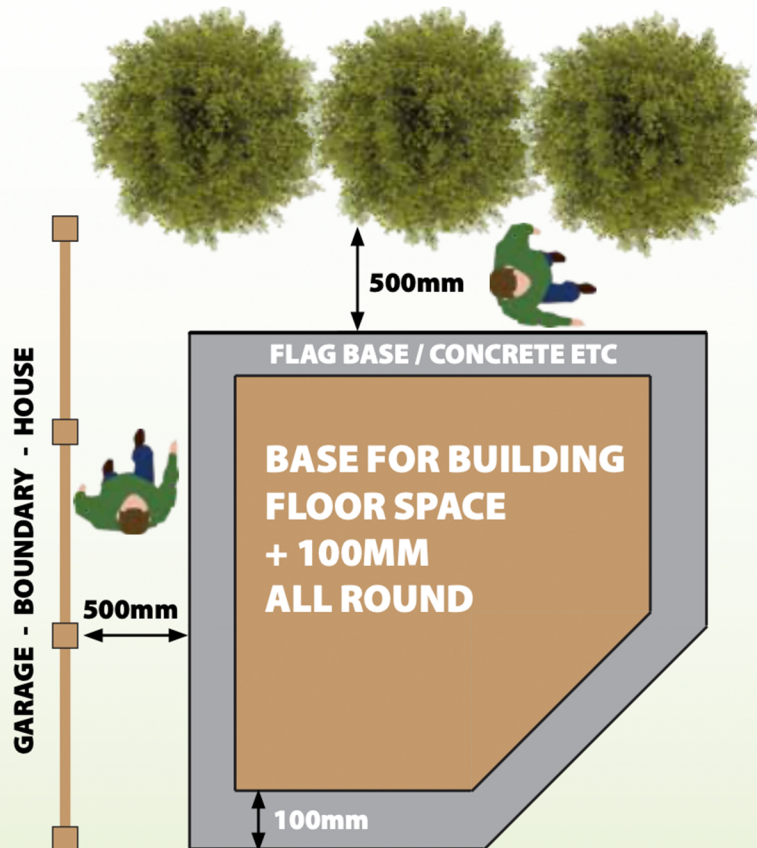

**Suitable Base Size
5.5m x 4.0m**



KEY POINTS FOR BASES

- Concrete base min 75mm must be floated off
- Timber base with support posts every metre square
- Must be perfect finish and level
- 500mm clearance only applicable to cabins and summerhouses